

USE OF EQUIPMENT LIGHTING DURING SNOWPLOW OPERATIONS: IDENTIFIED BEST PRACTICES

Laura Fay
PNS Conference
June 7, 2016
Session T9



Acknowledgements

- Co-Authors – Anburaj Muthumani and Dave Berger
- Clear Roads Technical Advisory Committee
- Survey participants
- Mark Trennepohl and Arizona DOT



Methodology

- Literature search
 - Used to develop survey questions and the best practices guide
- Agency survey
 - 58 responses representing 26 states within U.S
- Operator Survey
 - 369 responses representing 11 states within U.S
- Synthesis of Information
 - Summary of literature search and survey findings
 - Identifies the Pros and Cons, and makes Recommendations



Outline

- Introduction
- Methodology
- Auxiliary Headlights
- Mechanism to prevent snow blowing over the plow onto the windshield
- Warning lights
- Work lights
- Mechanism to keep light clear of snow
- Retro-reflective markings
- Day versus night settings
- Conclusions



Introduction

- The goal of this research project was to develop a summary of best practices in the use of headlights, work lights, and warning light technology in snowplow operations.



Introduction

- The project focuses on different:
 - types of light bulbs,
 - color of the light,
 - intensity of the light,
 - mounting locations,
 - flashing patterns and flashing interval,
 - amperage requirements,
 - mechanisms to prevent snow from blowing over the plow onto the windshield
 - mechanism to keep lights clear of snow,
 - retroreflective markings,
 - and day versus night settings for lights.



Auxiliary Headlights

- Typically located on the front of snowplow vehicles and provide supplemental illumination of the road surface during plowing.



Types of Auxiliary Headlight Bulbs

- Halogen bulbs followed by LED bulbs are the most commonly used bulb types for auxiliary headlights.
- LEDs are favored for use in new vehicles, retrofits, and replacements due to improved visibility.



Types of Auxiliary Headlight Bulbs

- Winter maintenance agencies are **moving towards use of LEDs** in their vehicle for auxiliary headlights.
- LED produced light appears closer to daylight
- Energy efficient
- Long service life
- Do not produce enough heat to melt snow



Comparison between Halogen and LEDs lights with high and low beam (www.truckinginfo.com)



MONTANA
STATE UNIVERSITY

College of
ENGINEERING

Western Transportation Institute

Mounting location and Beam width

- **Light bounce-back** from auxiliary lights during snowy conditions is a major safety issue.
- Mounting locations and beam width play a key role in reducing light bounce-back.
- Auxiliary headlights are primarily located on:
 - Truck body (most common)
 - Cab hood
 - Plow frame
 - Others (front fenders, on the grill, and top of headache rack)



Mounting location

- Previous studies suggest:
 - Mounting auxiliary headlights on the passenger side in snowy conditions
 - Mounting lamps **away from the operator's line of sight (passenger side)** was preferred over mounting lamps on the operator's line of sight (driver side).

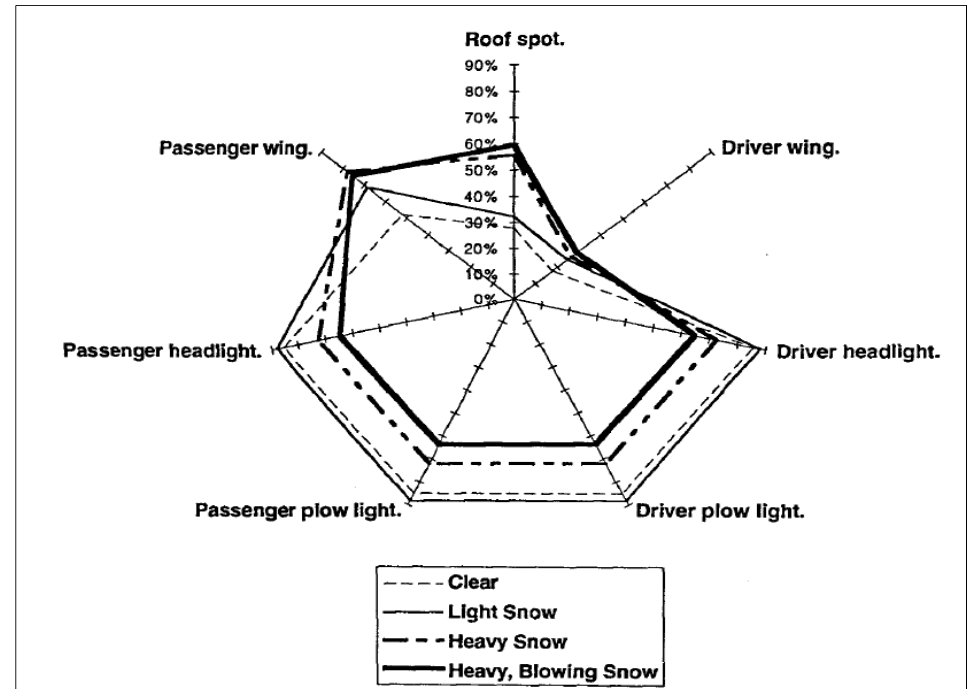

Percentage of operators using light under different weather conditions (Eklund et al., 1997)



Beam width

- Previous studies suggest:
 - **Narrower spot lamp** was preferred over the wide flood lamp

Subjective quality rating for spot lamps and flood lamps (Bullough and Rea, 1997) .

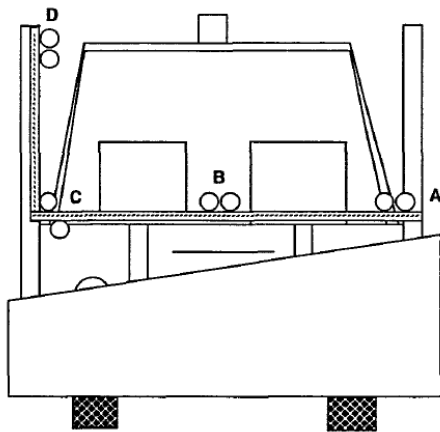

Front View

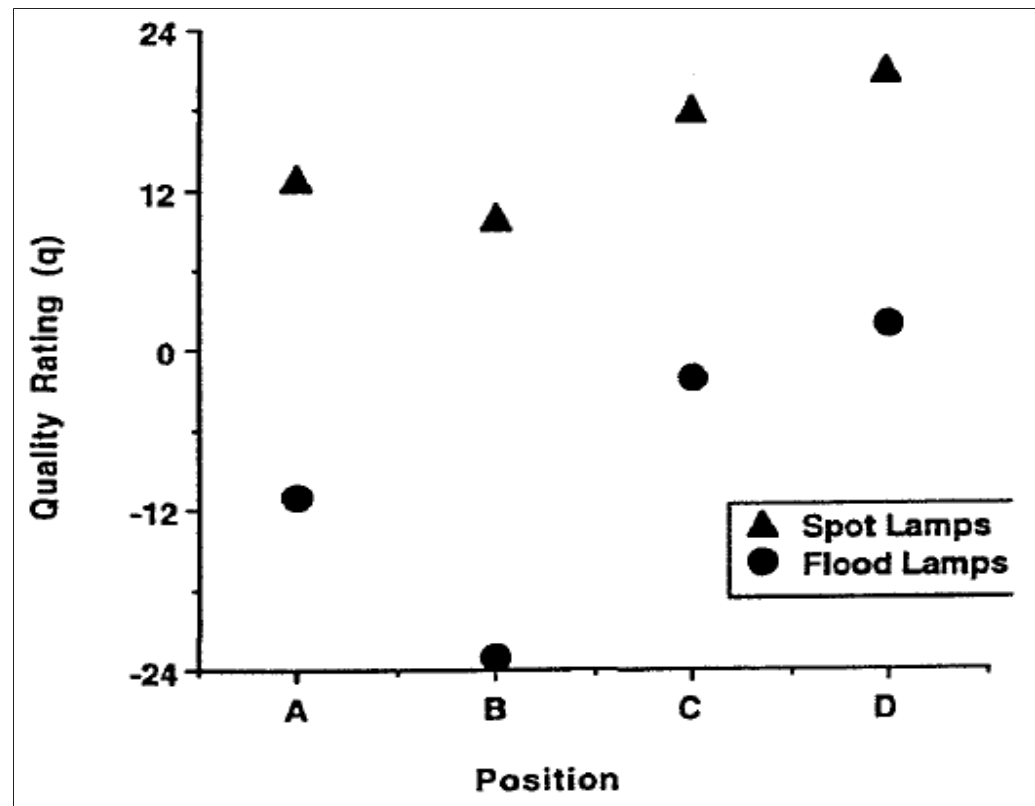

Mounting location and Beam width

- Survey Respondents indicated:
 - Mounting auxiliary headlights at **the lowest possible place** (above the plow or fender walls)
 - Con: Potential reflection of light from the back of the plow blade
 - Mounting auxiliary headlights on the top corners of the plow blade
 - Con: Potential of snow sticking on lights
 - Con: Decreased reliability of lights due to plow vibration
 - Con: Installation and wiring difficulties
 - **Narrow beam lights** preferred over wide beam lights



Mounting location and Beam width

- Identified Best Practices:
 - Mounting the auxiliary headlights **away from operator's line of sight with narrow beams** (spot light) helps to reduce the light bounce-back during adverse weather conditions.
 - In particular, mounting auxiliary headlights at the **lowest possible location** (above the plow or fender walls) is recommended.



Color of Auxiliary headlight bulbs

- The amount of light scatter is inversely proportional to the wavelength of light such that;
 - Blue light, with a shorter wavelength, will scatter more light than red light, a with longer wavelength.
- Yellow headlights were mandated rather than white headlights in France until 1990s
- Recent studies did not find any **significant advantages of using yellow or any other color lights** in reducing the glare during inclement weather conditions.



Color of Auxiliary headlight bulbs

- Recent studies did not find any **significant advantages of using yellow or any other color lights** for reducing glare during inclement weather conditions.
- In fact, the color of headlights may have little impact on improving visibility when compared to improvements made by changing **mounting location and beam width** during inclement weather conditions.



Warning lights

- Warning lights typically provide increased visibility of the snowplow by indicating the position and direction of travel.
- **Forward** warning lights
- **Rear** warning lights
- **Side-mount** warning lights



Type of Warning light bulbs

- Agencies prefer LEDs
 - reliability, improved efficiency, and reduced maintenance costs
- LEDs lights are brighter in all observed conditions and different light groups
- Minnesota DOT study found that LED lights performed well, or in some cases better when viewed directly from the rear, side, or front of the snowplow vehicle when compared to standard HID strobes.
 - Con: Limited visibility at off angles



Color of Warning light

- Indiana DOT study found that [amber is the preferred color](#) for all configurations followed by [bright blue](#) for warning lights
- Snowplow operators preferred [white color and amber colored](#) warning lights during low visibility (e.g., fog, snow, etc.) conditions
- Lights with red, orange, and yellow color components may have negative impacts during blowing snow and fog conditions ([Yonas and Zimmerman, 2006](#))



Color of Warning light

- NDDOT believes that **white color** is the most intense light to penetrate during low visibility conditions
- NDDOT is currently **testing steady burning - green** warning lights located outside the box
 - To differentiate DOT vehicles from other trucks (Oil trucks, construction trucks etc.,)
- Iowa DOT is also **testing flashing blue and white** LED lights on 175 snowplow vehicles
- ODOT is using **green flashing LED lights** placed atop its snowplow vehicles



Color of Warning light



The green lights demonstrated in snowy conditions on Nov. 18, 2014
(<http://woodtv.com/2014/11/13/kent-co-wants-new-green-lights-for-plow-trucks/>)



MONTANA
STATE UNIVERSITY

College of
ENGINEERING

Western Transportation Institute

Intensity of Warning light

- Agencies chose the brightest light bulb type for warning lights, such as LEDs.
- Survey respondents indicated **warning lights can never be too bright**
 - Brighter lights appear to better warn drivers approaching snowplows from the rear
 - suggest having **lower intensity settings** especially at night
 - For vehicles to keep a reasonable distance from the back of the snowplow vehicles



Flashing pattern and Interval

- The ability of a driver to detect the presence of a snowplow vehicle is different than the ability of the driver to detect the relative speed of the snowplow (perceived approach).
 - Flashing lights increase visibility of the snowplow for other vehicles
 - Steady-burn (constant burn) lights increase the ability of drivers to accurately perceive an approaching snowplow
- Previous studies suggest use of steady burning lights if agencies choose only one lighting system
- Flashing lights should not be excessively brighter than steady burning lights



Amperage Requirements

- Instantaneous and average power used by all LEDs fixtures are significantly lower than standard strobes (HID)
- LEDs may require heated lens (additional amperage) to stay clear of snow during snowy conditions

Electrical Characteristics of the tested strobes (Vogt and Miller, 2008)

Fixture description	Peak current (Amps)	Peak power (Watts)	Energy/cycle (Joules)	Average power (Watts)	Duty cycle (%)	Cycle time (sec)
Standard strobe	11.3	137.3	49.6	58.2	>0.7	0.82
Whelen LED	3.1	38.1	10.8	13.1	35	0.82
PSE 257 LED	5.9	73.0	37.4	41.9	58	0.89
Federal LED	3.8	46.0	46.0	15.9	25	2.90

Mounting location for warning lights

- Agencies are trying to mount the **forward warning lights to achieve complete visibility** from the rear and sides
- Rear warning lights are commonly **flush mounted**, or mounted on a pole or telespar, single or multiple beacons and surface mounted lights.
- Important to have a **reasonable distance between lights when using multiple colors** for rear warning lights.



Mounting location for warning lights

- NDDOT recommends elevating rear warning lights for increasing air flow around lights and reducing the snow accumulation.
- Must be careful during loading and unloading operations to avoid damaging the elevated lights



Rear warning lights mounted on the telespars, showing snow accumulation (NDDOT).



Proposed Mounting location for steady burn and flashing lights

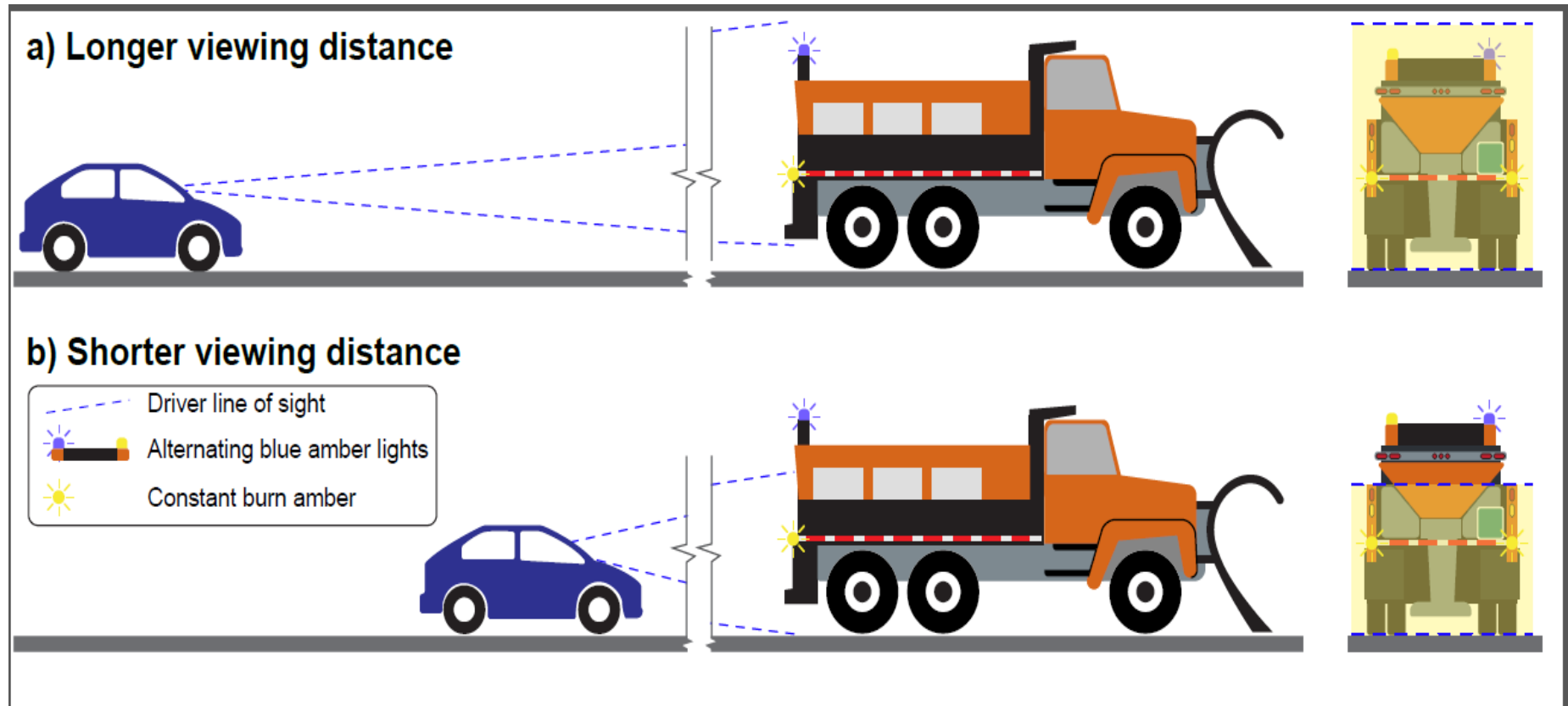

Work Lights

- Work lights are floodlights or spotlights mounted at various places on the truck exterior **for illumination of specific locations** such as a wing-plow, under-body plow, top of a truck bed, spreader-spinner, cab-steps, etc.
- Typical mounting locations of work lights identified by survey respondents are the **side and rear of the vehicles**.
- **LEDs and halogen bulbs** are the most commonly used light bulb for work lights
- **White color** is used by the majority of survey respondents
- Operators prefer additional work lights on tow plows, wing plows, top of the cab, under body lights, top of sanders (to keep track of materials), and some additional flood lights on the rear.

Mechanism to Prevent Snow Blowing over the Plow onto the Windshield

- Over plow deflectors
 - With trap angle less than 50°
- Very few survey respondents have over-plow deflectors on their vehicles
- Other options - air foils or bug shields.



Mechanism to Keep Lights Clear of Snow

- LEDs accumulate more snow than other light bulbs



Comparison of snow accumulation between standard strobe (left) and Whelen LED (right) after heavy snow conditions (Vogt and Miller, 2008).



Mechanism to Keep Lights Clear of Snow

- **Wind deflectors** mounted above the box of the snowplow were recommended to keep the rear warning lights free from snow build-up
- **Air foils** have been found to be effective in keeping the rear of vehicles clear of snow
- Iowa DOT recommended the use of “**scoop**” **tailgate deflectors** to decrease the amount of snow on the back of vehicles
- Wind deflectors may not be effective for tail lights and brake lights

Airfoil test run – without airfoil showing more snow accumulation on the rear (left); with airfoil showing less snow accumulation on the rear (right) (Nevada DOT, 2015).



Mechanism to Keep Lights Clear of Snow

- Nevada DOT suggested the **feasibility of thin sheet heaters** powered by a 12 volt source to be used on snowplow lights
- Heated lenses need a control switch
 - In cold snow events (around 15°F), heated lenses can create a dome of ice over the LED lens
- Alter the mounting locations of lights to enhance air flow around the lights.



Retro-reflective Markings

- Retro-reflective markings increase the visibility of the vehicle at night and during low-light conditions.
- Retro-reflective materials become completely ineffective if covered by snow and or dirt.
- The biggest issues with retro-reflective markings is keeping them 100% clean
- Most commonly used color combinations for reflective markings are red and white



Day Versus Night Settings

- The combination of more light sources and higher intensities may temporarily blind approaching vehicle drivers especially during nighttime operations
- Studies recommended using different intensity lighting for daytime and nighttime operations
- Day-versus-night time settings are not a commonly available feature in snowplow vehicles
- Very few respondents have manually operated day-versus-night light settings on their vehicles



Case Example – ADOT



- LED prototype front plow auxiliary lighting used on truck with 58” front plow.
- All lights are LED, cost to up fit with this package was \$3K.
- This truck was up fit with 100% LED lights in summer of 2014.
 - Winter 2014/2015 was relatively mild with few significant snow events. Therefore we’ve not fully tested this set up.
- Initially, the operators like the visibility provided by this lighting, but due to being in the drivers direct line of sight, bounce back is an issue.



A yellow truck is shown from a front-quarter perspective. The truck has several lights: a large round LED headlamp on the left side of the hood, a smaller round fog lamp below it, and a large fog lamp with a 'KC' logo on the grille. The truck is parked in front of a building with a white tarp. The sky is clear blue.

Truck-Lite 27270C 7
Round LED Headlamp,
2 LED Arrays Multi-volt,
@ 12.8v operation, high
beam function draws
3.60a, low beam function
draws 1.80a 1,300

KC 1851 HID Fog Lamp,
35 watt, 350,000 beam
candlepower

KC 1668 HID Fog
Lamp, 50 watt,
305,000 candlepower

F488

FREIGHT

Equipment and Labor Costs

- 7 in LED clear flood light (2) \$641.66
- 5x7 in LED clear kit light (1) \$845.07
- 7 in LED clear spot light (2) \$665.96

- Labor 11.5 hrs \$753.25

- Total Costs for upgrade: **\$2919.94**



Plow Driver Survey

- **Light bounce back and scatter was rated *better* (6/10) with the new set up.**
 - Driver comment: the lower the mounting or off to the passenger side the lights are the better.
- **Driver visibility was also rated *better* (7.5/10)**
 - Driver comments: if we can get the heated lenses on the LED lights as you have to stop frequently to clear snow and ice off.
- **Effects of plow lights to oncoming traffic**
 - Driver comments: Were not bad, but adjusted lights anyway toward the fog line, away from oncoming traffic.



Plow Driver Survey

- Overall rating for lighting package: 8/10
 - The only recommended change is to include the heated lens on the LED fender mounted lights
- Rated each lighting type:
 - Fender mounted HID 6” fog: 8.5/10, don’t freeze up and seem to cut through the snow well.
 - Fender mounted LED: 4.5/10, because of the icing issue if they were heated I would rate them a lot higher.
 - Plow frame mounted HID 8” fog: 8.5/10, cut through the snow and do not ice up.



2013 model plow truck retrofitted with 100% LED plow lights and installed a switch in the cab that shuts off the driver side lights. 



- Testing this year in moderate snow and heavy fog driver found:
 - Used the plow light shut off switch frequently, except during night time clean-up activities.
- *Based on its success, AzDOT is wondering if they should add on-off switches to all of their plows.

Conclusions

- Halogen bulbs followed by **LED bulbs are the most commonly** used bulb types for auxiliary headlights. LEDs are favored for use in new vehicles, retrofits, and replacements due to improved visibility.
- Mounting the auxiliary headlights **away from the snowplow operators line of sight with narrow beams** (spot light) helps to reduce the light bounce-back during adverse weather conditions. In particular, mounting auxiliary headlights at the **lowest possible location** (above the plow or fender walls) is recommended.



Conclusions

- With the emergence of LEDs for auxiliary headlights, warning lights, and work lights, it is important to have some mechanism to keep the lights clear of snow because LEDs do not produce enough heat to melt snow and ice off the light surface.
- Over-plow deflectors have been found to be effective in keeping the front grill clear of snow.



Conclusions

- **Amber** is the color most commonly used for warning lights. However, agencies are using and/or testing blue, white, and green colors. **Operators prefer white colored warning lights** because of perceived increased conspicuity during low visibility (e.g., fog, storm conditions, etc.) conditions.
- It is important to have both **flashing lights and steady burning (constant burn) lights that are spaced apart for rear warning lights**. Flashing lights help to identify the presence of a plow and steady burn lights aid in the estimation of the relative speed of plow.



Conclusions

- Retro-reflective tape markings are very effective and provide an additional level of warning for approaching vehicles. However, **keeping retro-reflective markings clear of snow and visible at all times is an issue** during snow plowing operations.
- A combination of **wind deflectors and heated lens** can be used to keep the warning lights and retro-reflective tape clear of snow. However, it is important to have a control switch that can turn on and off the heated lenses based on the conditions.



Conclusions

- The issue of **increased brightness** introduced by warning lights can be resolved by using **day-versus-night settings** for lights on snowplow vehicles, but this feature is **not commonly available**.



Questions?

Final Report can be found here:

<http://clearroads.org/project/use-of-equipment-lighting-during-snowplow-operations/>

Laura Fay

laura.fay1@montana.edu

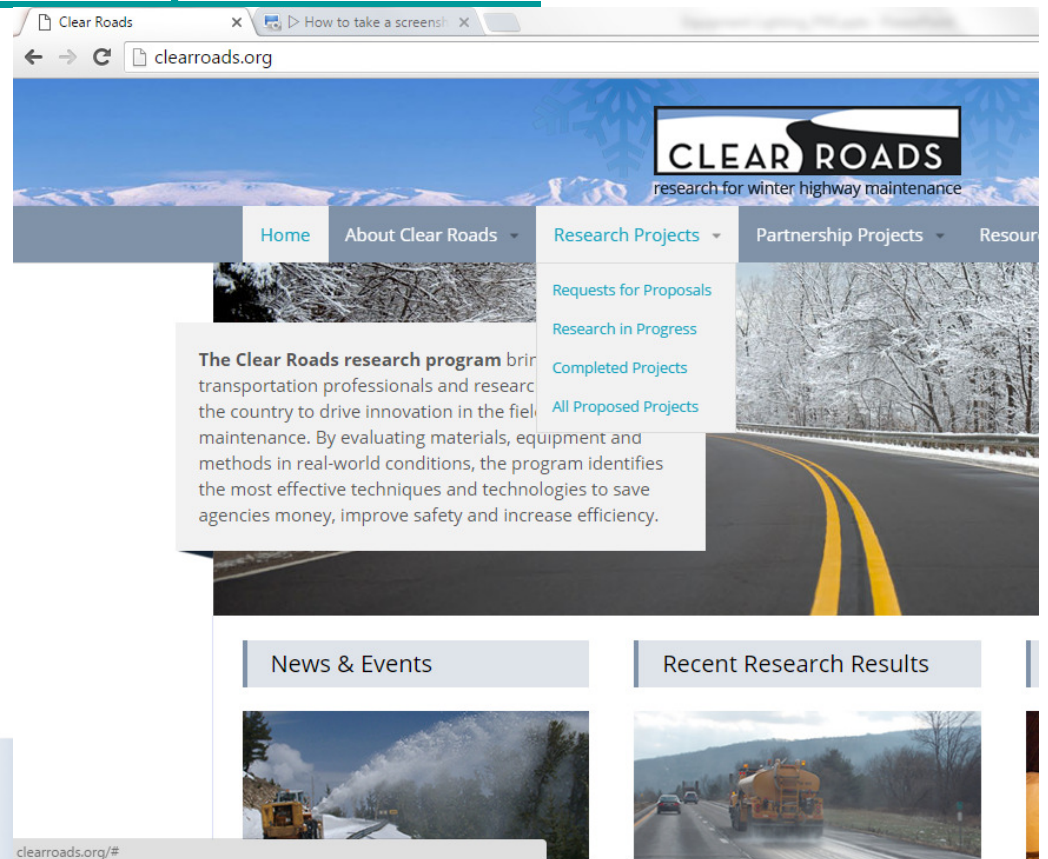

MONTANA
STATE UNIVERSITY

College of
ENGINEERING

clearroads.org/#